

YEARS: 2011-PRESENT

MAKE: VOLKSWAGEN / PORSCHE

MODEL: TOUAREG / CAYENNE

STYLE: SUV

WARNING: NEVER EXCEED YOUR VEHICLE MANUFACTURER'S RECOMMENDED TOWING CAPACITY







WEIGHT CARRYING:
 TRAILER WEIGHT: 6,000 LBS.
 TONGUE WEIGHT: 600 LBS.

WARNING:
 WE RECOMMEND THE USE OF 18050 STABILIZING STRAPS FOR ALL NON-TRAILER (WHEEL-LESS) LOADS. PLEASE SEE THE CURT CATALOG OR VISIT US ONLINE AT WWW.CURTMFG.COM FOR FURTHER INFORMATION.

INSTALLATION TIME: 75 MIN.

THE INSTALL TIME LISTED IS FOR PROFESSIONAL INSTALLERS. IF YOU ARE HESITANT TO UNDERTAKE THIS TASK ON YOUR OWN, CONTACT AN AUTHORIZED CURT INSTALLER FOR ADDITIONAL ASSISTANCE.

INSTALLATION REQUIRES:

 T-15, T-25 & T-30 TORXBIT SOCKET	 11mm 18mm SOCKET	 RATCHET
 TORQUE WRENCH	 SMALL PUNCH	 FLAT HEAD SCREW DRIVER
 SAFETY GLASSES		

INSTALLATION TIPS:

- BEFORE YOU BEGIN INSTALLATION, READ ALL INSTRUCTIONS THOROUGHLY.
- TO EASE INSTALLATION, 2 PEOPLE MAY BE REQUIRED.
- USING PROPER TOOLS WILL GREATLY IMPROVE THE QUALITY OF THE INSTALL AND REDUCE THE TIME REQUIRED.
- NEED HELP OR HAVE SOME QUESTIONS? CALL TECHNICAL SUPPORT AT 800.798.0813

LEVEL OF DIFFICULTY: CHALLENGING

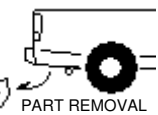
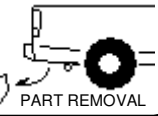
EASY	MODERATE	CHALLENGING
	NO DRILLING REQUIRED	
	BUMPER COVER REMOVAL	
	HITCH REPLACES BUMPER BEAM	

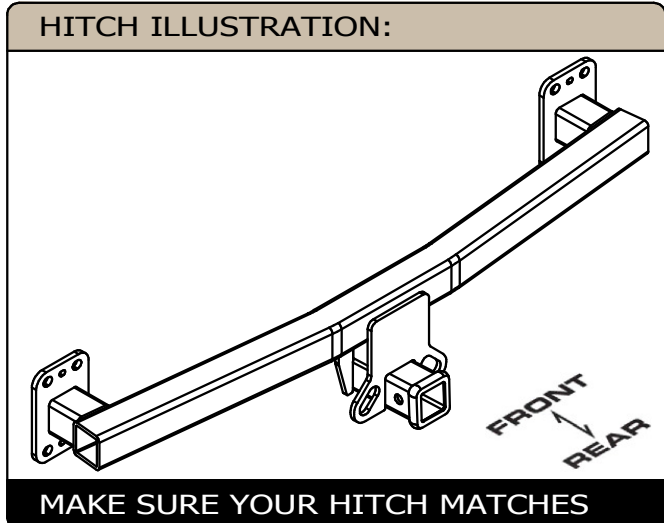
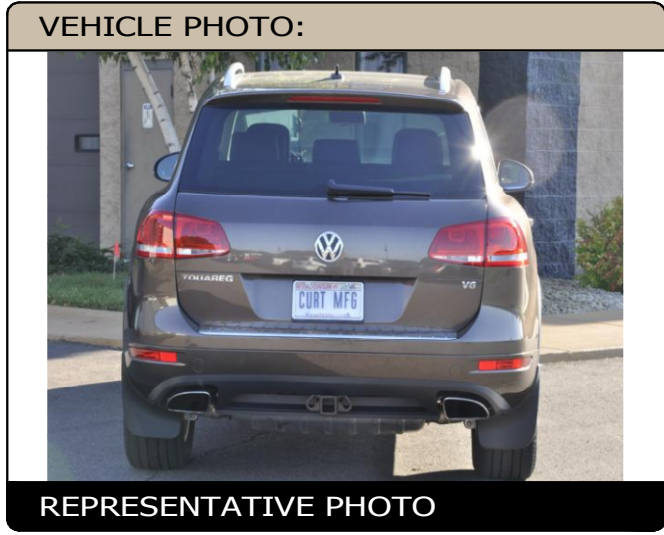

PERIODICALLY CHECK THIS RECEIVER HITCH TO ENSURE ALL FASTENERS ARE TIGHT AND ALL STRUCTURAL COMPONENTS ARE SOUND

CURT Manufacturing LLC. warrants this product to be free of defects in material and/or workmanship at the time of retail purchase by the original purchaser. If the product is found to be defective, Curt Manufacturing LLC. may repair or replace the product at their option, when the product is returned, prepaid, with proof of purchase. Alteration to, misuse of, or improper installation of this product voids the warranty. Curt Manufacturing LLC.'s liability is limited to repair or replacement of products found to be defective, and specifically excludes liability for incidental or consequential loss or damage.

For more information log onto www.curtmfg.com, & for helpful towing tips log onto www.hitchinfo.com

INSTALLATION WALKTHROUGH:

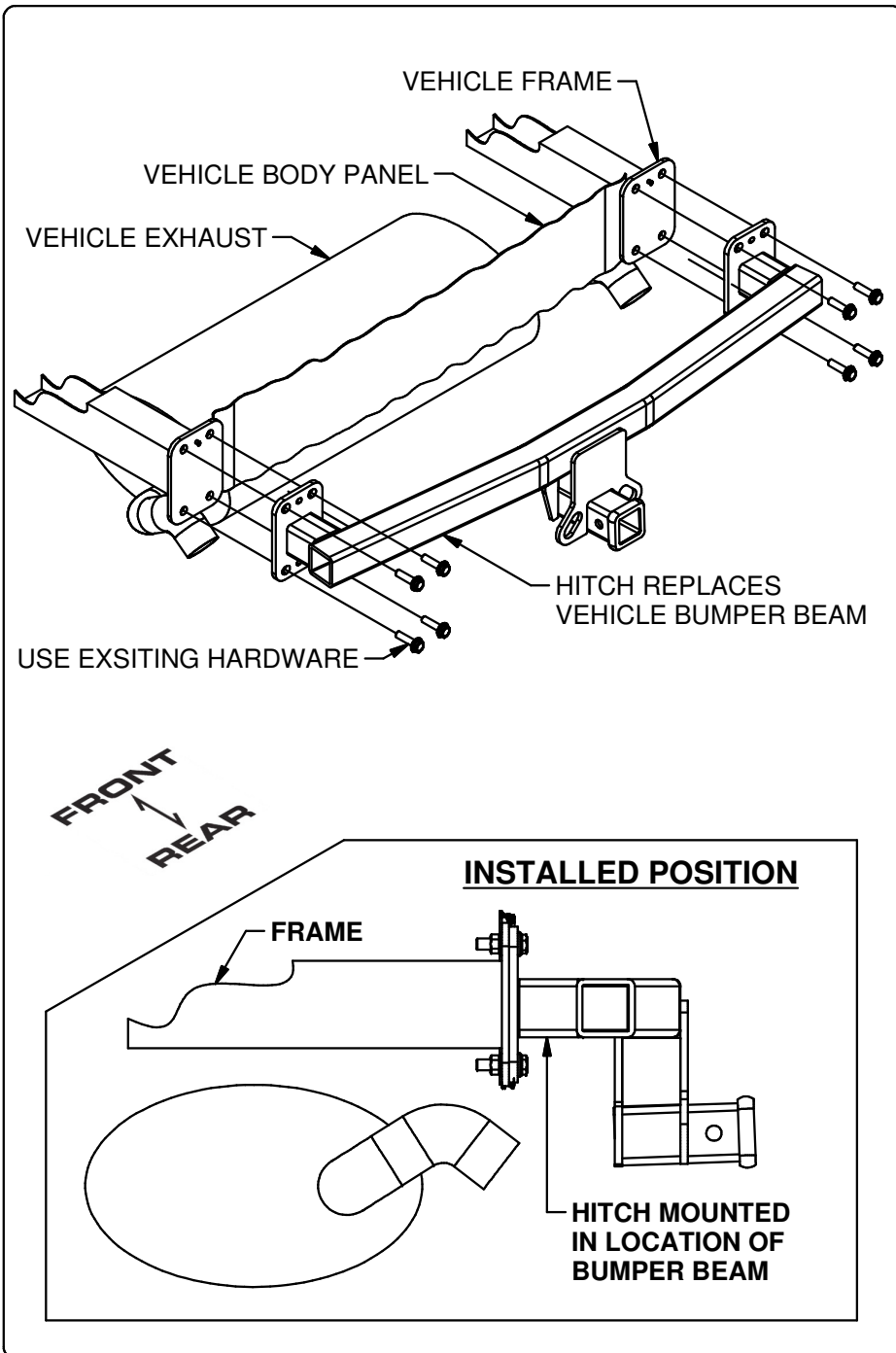

1. Remove (4) torx head fasteners which attach bottom rear portion of bumper cover to vehicle.

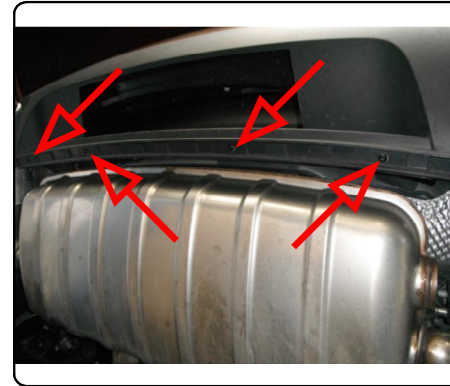

2. Remove mud flap from behind each rear tire by unfastening (5) torx head screws from each. **Note:** Underside fasteners have a nut attached.

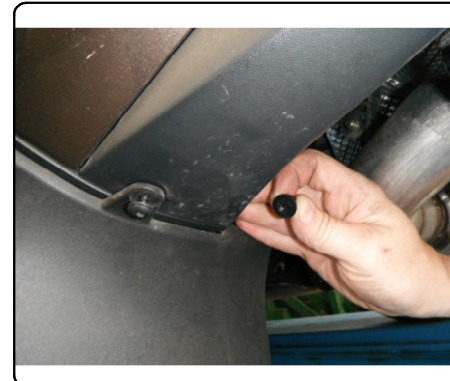

INSTALLATION WALKTHROUGH:

3. Remove fastener which holds wheel well trim to fascia. Carefully pop off wheel well trim. **Note:** Only the rear half of the trim needs to be removed.

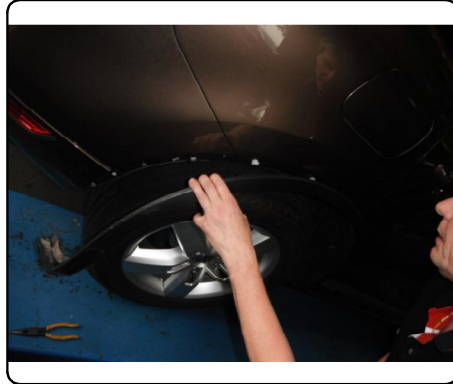

4. Remove (4) torx head fasteners from under wheel well trim.

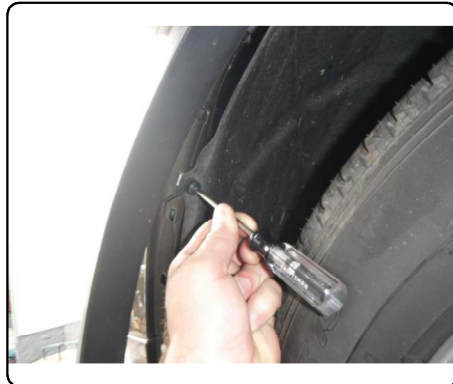

- 5a. On VW Touareg remove the vehicle tail lights by loosening nut from inside vehicle using a 11mm socket. Driver side nut is accessible through circular plastic clip and the passenger side through rectangular clip. Carefully slide the light out and unfasten the electrical clip. See step 5b for Porsche Cayenne tail light removal

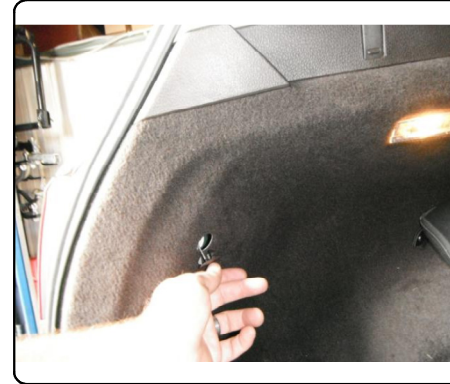

- 5b. On Porsche Cayenne remove the vehicle tail lights by taking of the panel shown on the photo. Then remove the panel cover to reveal the nuts on the inside of the tail light. Remove the nuts and carefully slide out the light and unfasten the electrical clip.

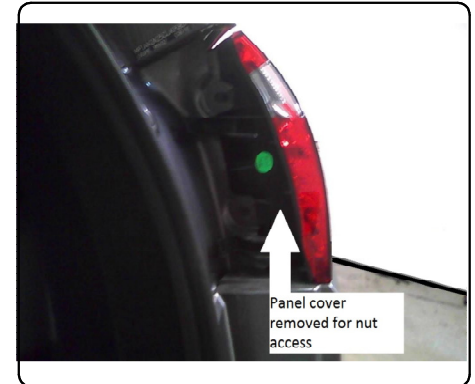

INSTALLATION WALKTHROUGH:

6. Remove (2) torx head fasteners and (1) push fastener from each side. These are now accessible due to tail light removal. **Note:** Use a small punch or equivalent to push the center of push fastener down then pry up.



7. Carefully remove bumper cover. Pop sides off first, then pull straight back.

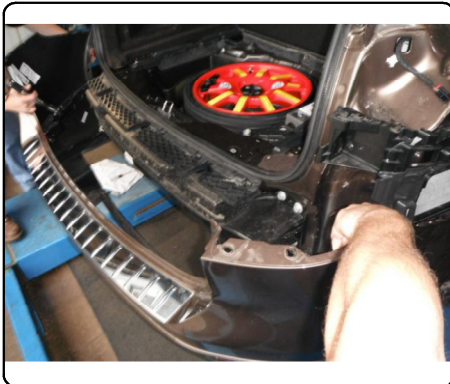

8. Remove foam insert. Remove bumper beam by unfastening (8) M12 bolts. These bolts will be used to install the hitch. Return bumper beam to vehicle owner.



9. Install the hitch using the M12 bolts removed in step 8. Foam insert can be discarded or trimmed and reinstalled. **Note:** Trim foam so it loosely fits into position.

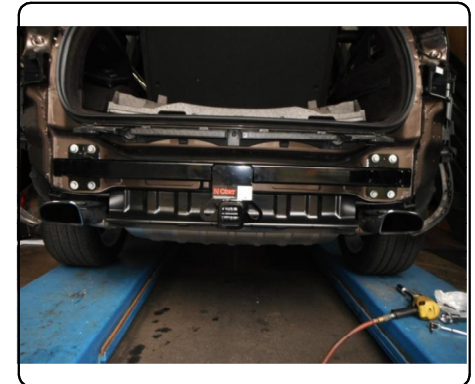

INSTALLATION WALKTHROUGH:

10. Torque all 12M fasteners to 82 ft-lbs and reinstall all components removed in steps 1-7

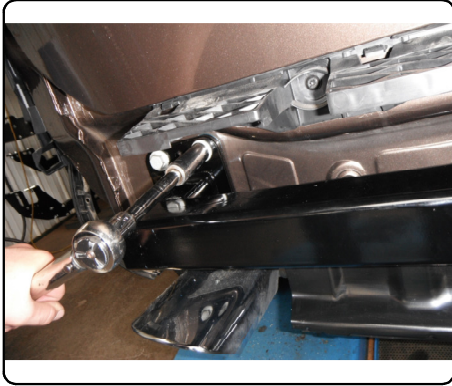

13116

VOLKSWAGEN TOUAREG / PORSCHE CAYENNE

4/26/2013

GROSS LOAD CAPACITY WHEN USED AS A WEIGHT CARRYING HITCH: 6,000 LBS. TRAILER WEIGHT & 600 LBS. TONGUE WEIGHT.

DO NOT EXCEED VEHICLE MANUFACTURER'S RECOMMENDED TOWING CAPACITY.

WARNING: ALL NON-TRAILER LOADS APPLIED TO THIS PRODUCT MUST BE SUPPORTED BY AUXILIARY STABILIZING STRAPS.

** FAILURE TO PROPERLY SUPPORT NON-TRAILER LOADS WILL VOID PRODUCT WARRANTY**

HAVING INSTALLATION QUESTIONS? CALL TECHNICAL SUPPORT AT 1-800-798-0813

TOOLS REQUIRED

T-15, T-25 & T-30 TORX
11mm & 18mm SOCKETS
RATCHET
TORQUE WRENCH
SMALL PUNCH
FLAT HEAD SCREWDRIVER
SAFETY GLASSES

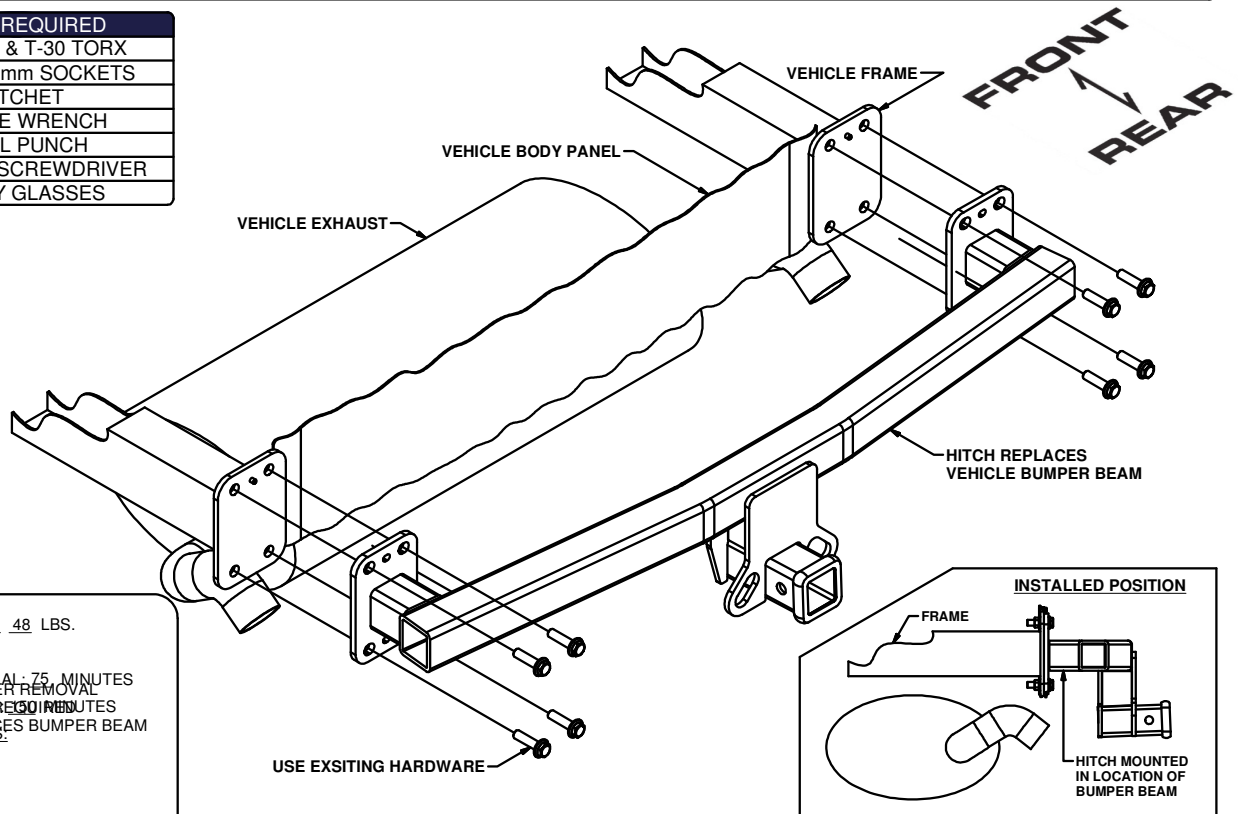

HITCH WEIGHT: 48 LBS.

INSTALL TIME

- PROFESSIONAL: 75 MINUTES
- BUMPER COVER REMOVAL
- NO DRILLING REQUIRED
- HITCH REPLACES BUMPER BEAM
- INSTALL NOTES

INSTALLATION STEPS

1. Remove (4) torx head fasteners which attach bottom rear portion of bumper cover to vehicle.
2. Remove mud flap from behind each rear tire by unfastening (5) torx head screws from each. **Note:** Underside fasteners have a nut attached. Remove fastener which holds wheel well trim to fascia.
3. Carefully pop off wheel well trim. **Note:** Only the rear half of the trim needs to be removed.
4. Remove (4) torx head fasteners from under wheel well trim.
- 5a. On VW Touareg remove the vehicle tail lights by loosening nut from inside vehicle using a 11mm socket. Driver side nut is accessible through circular plastic clip and the passenger side through rectangular clip. Carefully slide the light out and unfasten the electrical clip. See step 5b for Porsche tail light removal.
- 5b. On Porsche Cayenne remove the vehicle tail lights by taking of the panel on the left side of the light. Then remove the panel cover to reveal the nuts on the inside of the tail light. Remove the nuts and carefully slide out the light and unfasten the electrical clip.
6. Remove (2) torx head fasteners and (1) push fastener from each side. These are now accessible due to tail light removal. **Note:** Use a small punch or equivalent to push the center of push fastener down then pry up.
7. Carefully remove bumper cover. Pop sides off first, then pull straight back.
8. Remove foam insert. Remove bumper beam by unfastening (8) M12 bolts. These bolts will be used to install the hitch. Return bumper beam to vehicle owner.
9. Install the hitch using the M12 bolts removed in step 8. Foam insert can be discarded or trimmed and reinstalled. **Note:** Trim foam so it loosely fits into position.
10. Torque all 12M fasteners to 82 ft-lbs and reinstall all components removed in steps 1-7

PERIODICALLY CHECK THIS RECEIVER HITCH TO ENSURE THAT ALL FASTENERS ARE TIGHT AND THAT ALL STRUCTURAL COMPONENTS ARE SOUND.

Curt Manufacturing Inc., warrants this product to be free of defects in material and/or workmanship at the time of retail purchase by the original purchaser. If the product is found to be defective, Curt Manufacturing Inc., may repair or replace the product, at their option, when the product is returned, prepaid, with proof of purchase. Alteration to, misuse of, or improper installation of this product voids the warranty. Curt Manufacturing Inc.'s liability is limited to repair or replacement of products found to be defective, and specifically excludes liability for incidental or consequential loss or damage.