

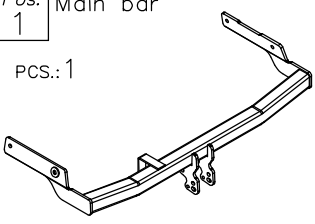











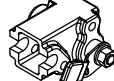
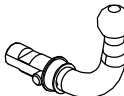

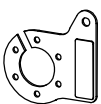
Towbar accessories:

Pos. 1 Main bar PCS.: 1 	Pos. 6 Bolt 8,8 B M8x45mm PCS.: 1 	Pos. 12 Spring washer ø10,2mm PCS.: 4 
	Pos. 7 Caget nut M10 PCS.: 4 	Pos. 13 Body of the automat PCS.: 1 
Pos. 2 Tow ball PCS.: 1 	Pos. 8 Plain washer ø13mm PCS.: 4 	Pos. 14 Nut 8 B M8 PCS.: 1 
Pos. 3 Socket plate PCS.: 1 	Pos. 9 Plain washer ø10,5mm PCS.: 4 	Pos. 15 Spring PCS.: 1 
Pos. 4 Bolt 8,8 B M12x25mm PCS.: 4 	Pos. 10 Plain washer ø8,5mm PCS.: 2 	Pos. 16 Ball cover PCS.: 1 
Pos. 5 Bolt 8,8 B M10x35mm PCS.: 4 	Pos. 11 Spring washer ø12,2mm PCS.: 4 	Pos. 17 Body plug PCS.: 1 



PPUH AUTO-HAK Sp.J.

Produkcja Zaczepów Kulowych
Henryk & Zbigniew Nejman
76-200 SŁUPSK ul. Słoneczna 16K
tel/fax (059) 8-414-414; 8-414-413
E-mail: office@autohak.com.pl
www. autohak.com.pl

Towing hitch (without electrical set)

Class: **A50-X** Cat. no. **F27A**

Designed for:

Manufacturer: **PEUGEOT**

Model: **206**

Type: **3/5 doors, CC**

produced since 1998 till 03.2003

produced since 03.2003 till 2009

Manufacturer: **PEUGEOT**

Model: **206+**

produced since 2009

Technical data:

D-value: 6,42 kN

maximum trailer weight: **1100 kg**

maximum vertical cup load: **50 kg**

Approval number according to Directive 94/20/EC: **e20*94/20*1060*00**

Foreword

This towbar is designed according to rules of safety traffic regulations. The towing hitch is a safety component and must be installed only by qualified personnel. Any alteration or conversion to the towing hitch is prohibited and would lead to cancellation of design certification. Remove insulating compound and underseal from vehicle (if present) in the area of the matting surfaces of the towing hitch.

The vehicle manufacturer's specifications regarding trailer load and max. vertical cup load are decisive for driving, and values for the towing hitch must not be exceeded.

D-value formula:

$$\frac{\text{Max trailer weight [kg]} \times \text{Max vehicle weight [kg]}}{\text{Max trailer weight [kg]} + \text{Max vehicle weight [kg]}} \times \frac{9,81}{1000} = D \text{ [kN]}$$

FITTING INSTRUCTION

Clamp mark in acc. with		Cables joining
ISO	PN	
1	L	Left directional lights
2	+	Rear fog lights
3	31	Ground
4	R	Right directional lights
5	58R	Right side parking lights
6	54	Stoplights
7	58L	Left side parking lights

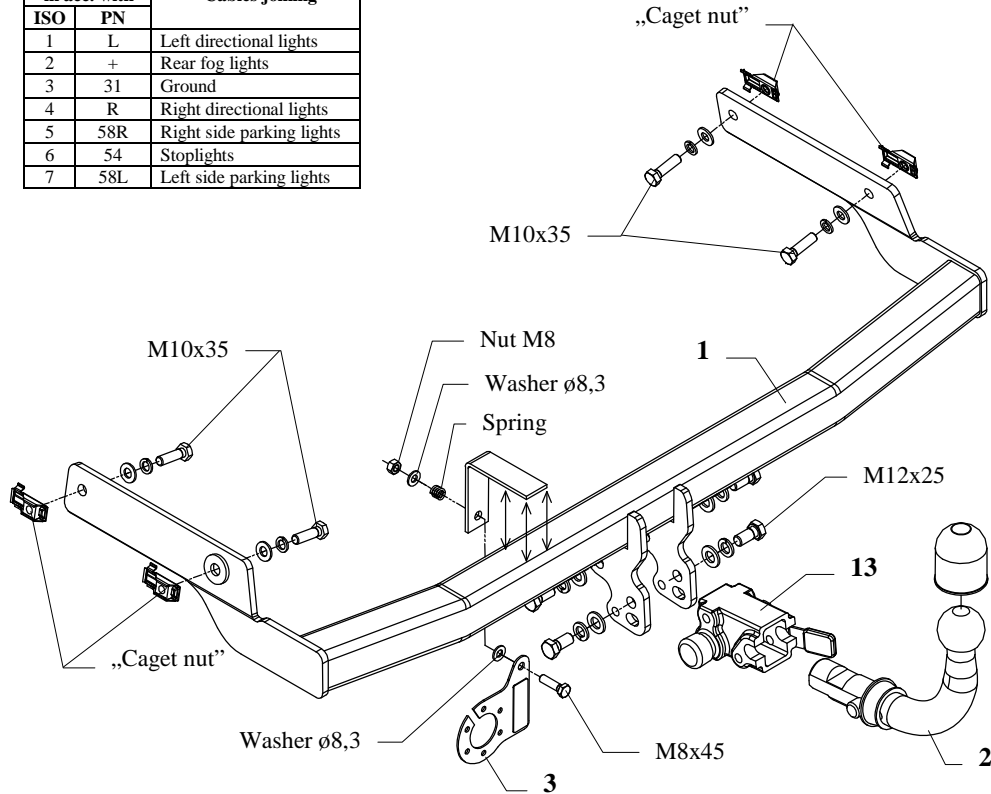

This towbar is designed to assembly in following car: **PEUGEOT 206, 3/5 doors, CC**, produced since 1998 till 03.2003 and since 03.2003 till 2009 and **PEUGEOT 206+** produced since 2009, catalogue number **F27A** and is prepared to tow trailers max total weight **1100 kg** and max vertical load **50 kg**.

Foreword

Thank you for buying our product. This towbar is design according to rules of safety traffic regulations and their reliability has been confirmed in many tests. Reliability of towbar also depends on correct assembly and correct exploitation. For this reasons we kindly ask to read carefully this instruction and apply to hints.

The towbar should be install in places described by a car producer.

The instruction of the assembly

1. Disassemble two handles in the lower part of the bumper and take down the muffler (take down from the rubber handles).
2. In existing holes in left and right chassis member put per two special nuts (Caget Nut, 44x17mm).
3. Cut out fragment of the bumper (in axis of symmetry, in bottom edge) width 80mm and depth 80mm.
4. Put the main bar of the towbar (pos. 1) to chassis members in this way, so towbar holes agree to nuts (previously inserted) and fix all using bolts M10x35mm (pos. 5) from accessories.
5. Tighten all bolts according to the torque shown in the table.
6. Fix body of the automat (pos. 13) using bolts M12x25mm (pos. 4) from accessories. Place tow-ball (pos. 2) according to supplied instruction.
7. Fix the socket plate (pos. 3) as shown on the drawing.
8. Assemble the muffler.
9. Connect electric wires of 7-poles socket according to the instruction of the car. (Recommend to make at authorized service station).
10. Complete paint layer damaged during installation.

Torque settings for nuts and bolts (8,8):

M6 - 11 Nm	M8 - 25 Nm	M10 - 50 Nm
M12 - 87 Nm	M14 - 138 Nm	M16 - 210 Nm

NOTE

After install the towbar you should get adequate note in registration book (at authorised service station).The car should be equipped with:

- Indicators
- Tow mirrors

After 1000km of exploitation check all bolts and nuts. The ball of towbar must be always kept clear and conserve with a grease.