

FITTING INSTRUCTION

Clamp mark in acc. with		Cables joining
ISO	PN	
1	L	Left directional lights
2	+	Rear fog lights
3	31	Ground
4	R	Right directional lights
5	58R	Right side parking lights
6	54	Stoplights
7	58L	Left side parking lights

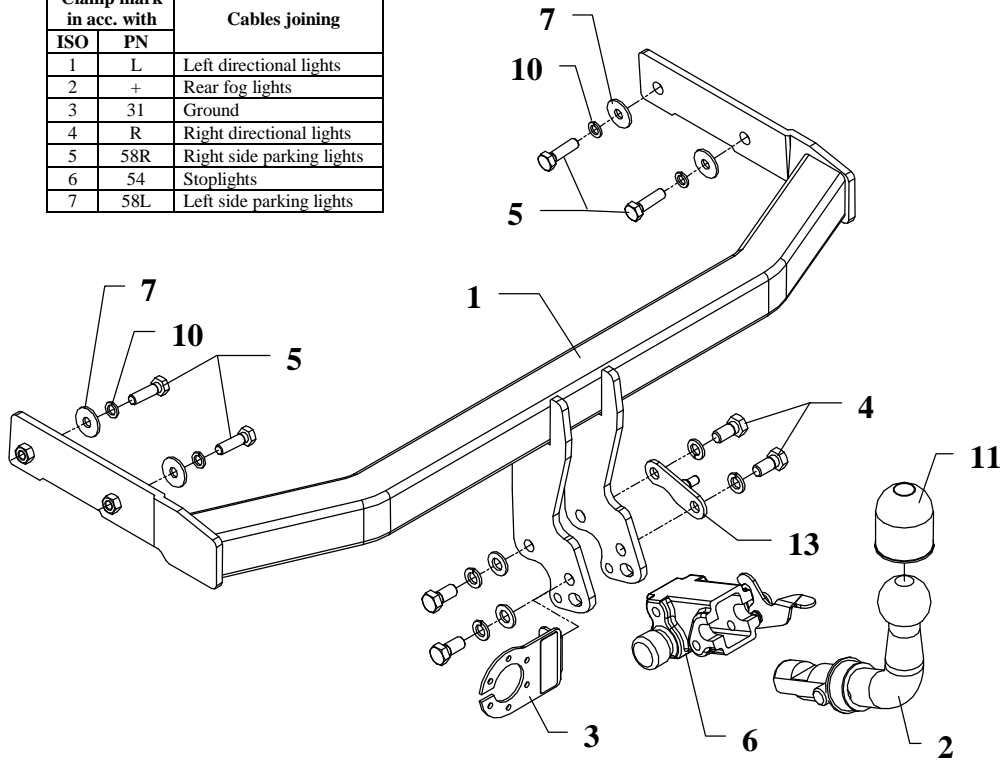

This towbar is designed to assembly in following cars:
VOLKSWAGEN LUPO, 3 doors, produced since 1998 till 2005 and
SEAT AROSA, 3 doors, produced since 1997 till 2000 and since 2000 till 2004, catalogue no. **K07A** and is prepared to tow trailers max total weight **850 kg** and max vertical load **50 kg**.

From manufacturer

Thank you for buying our product. Their reliability has been confirmed in many tests. Reliability of towbar depends also on correct assembly and right operation. For this reasons we kindly ask to read carefully this instruction and apply to hints.

The towbar should be install in points described by a car producer.

The instruction of the assembly

1. Disassemble the bumper and its metal part (this part will not be used any more).
2. Lower the muffler, reassemble its support and thermal shield.
3. Disassemble plastic fuel pipes on the right side, then deflect them, it help us to get to the place where the towbar is going to be mounted.
4. Find original holes aside the chassis members (they are cover with tape).
5. Slide the main bar of the towbar (pos. 1) to chassis members, then fix it using bolts M10x35mm (pos. 5) and big washers (pos. 7).
6. Cut the bumper according to the fig. 2.
7. Reassemble the bumper.
8. Fix body of the automat (pos. 6) and the socket plate (pos. 3) using bolts M12x25mm (pos. 4) from accessories. Place tow-ball (pos. 2) according to supplied instruction.
9. Tighten all bolts according to the torque shown in the table.
10. Connect electric wires of 7-poles socket according to the instruction of the car. (Recommend to make at authorized service station)
11. Complete the paint layer of towbar (during the mounting paint layer could be damaged).

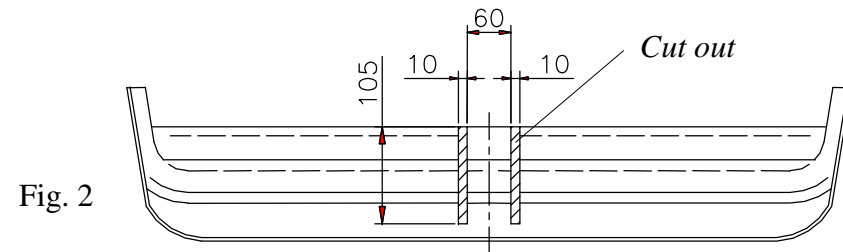

Torque settings for nuts and bolts (8,8):		
M6 - 11 Nm	M8 - 25 Nm	M10 - 50 Nm
M12 - 87 Nm	M14 - 138 Nm	M16 - 210 Nm









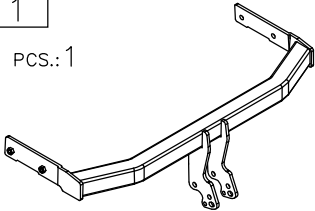

NOTE

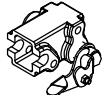
After install the towbar you should get adequate note in registration book (at authorised service station).The car should be equipped with:

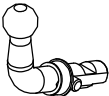
- Indicators
- Tow mirrors

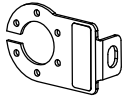
After 1000km of exploitation check all bolts and nuts. The ball of towbar must be always kept clear and conserve with a grease.

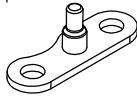
Towbar accessories:

Pos. 1	Main bar 	PCS.: 1
Pos. 5	Bolt 8,8 B M10x35mm 	PCS.: 4
Pos. 10	Spring washer ø10,2mm 	PCS.: 4
Pos. 6	Body of the automat 	PCS.: 1
Pos. 11	Ball cover 	PCS.: 1
Pos. 2	Tow ball 	PCS.: 1
Pos. 7	Plain washer ø30xø10,5x2,5mm 	PCS.: 4
Pos. 12	Body plug 	PCS.: 1
Pos. 3	Socket plate 	PCS.: 1
Pos. 8	Plain washer ø13mm 	PCS.: 4
Pos. 13	Safety fish-plate 	PCS.: 1
Pos. 7	Bolt 8,8 B M12x25mm 	PCS.: 4
Pos. 9	Spring washer ø12,2mm 	PCS.: 4



PPUH AUTO-HAK S. J.

Produkcja Zaczepów Kulowych
Henryk & Zbigniew Nejman
76-200 SŁUPSK ul. Słoneczna 16K
tel/fax (059) 8-414-414; 8-414-413
E-mail: office@autohak.com.pl
www.autohak.com.pl

Towing hitch (without electrical set)

Class: **A50-X** Cat. no. **K07A**

Designed for:

VOLKSWAGEN LUPO, 3 doors,
produced since 1998 till 2005
and

SEAT AROSA, 3 doors,

produced since 1997 till 2000 and since 2000 till 2004

Technical data:

D-value: 5,08 kN

maximum trailer weight: **850 kg**

maximum vertical cup load: **75 kg**

Approval number according to Directive 94/20/EC: e20*94/20*1166*00

Foreword

This towbar is designed according to rules of safety traffic regulations. The towing hitch is a safety component and can be install only by qualified personnel. Any alteration or conversion of the towing hitch is prohibited and would lead to cancellation of design certification. Remove insulating compound and underseal from vehicle (if present) in the area of the matting surfaces of the towing hitch.

The vehicle manufacturer's specifications regarding trailer load and max. vertical cup load are decisive for driving, and values for the towing hitch cannot be exceeded.

D-value formula:

$$\frac{\text{Max trailer weight [kg]} \times \text{Max vehicle weight [kg]}}{\text{Max trailer weight [kg]} + \text{Max vehicle weight [kg]}} \times \frac{9,81}{1000} = D \text{ [kN]}$$