

FITTING INSTRUCTION

Clamp mark in acc. with		Cables joining
ISO	PN	
1	L	Left directional lights
2	+	Rear fog lights
3	31	Ground
4	R	Right directional lights
5	58R	Right side parking lights
6	54	Stoplights
7	58L	Left side parking lights

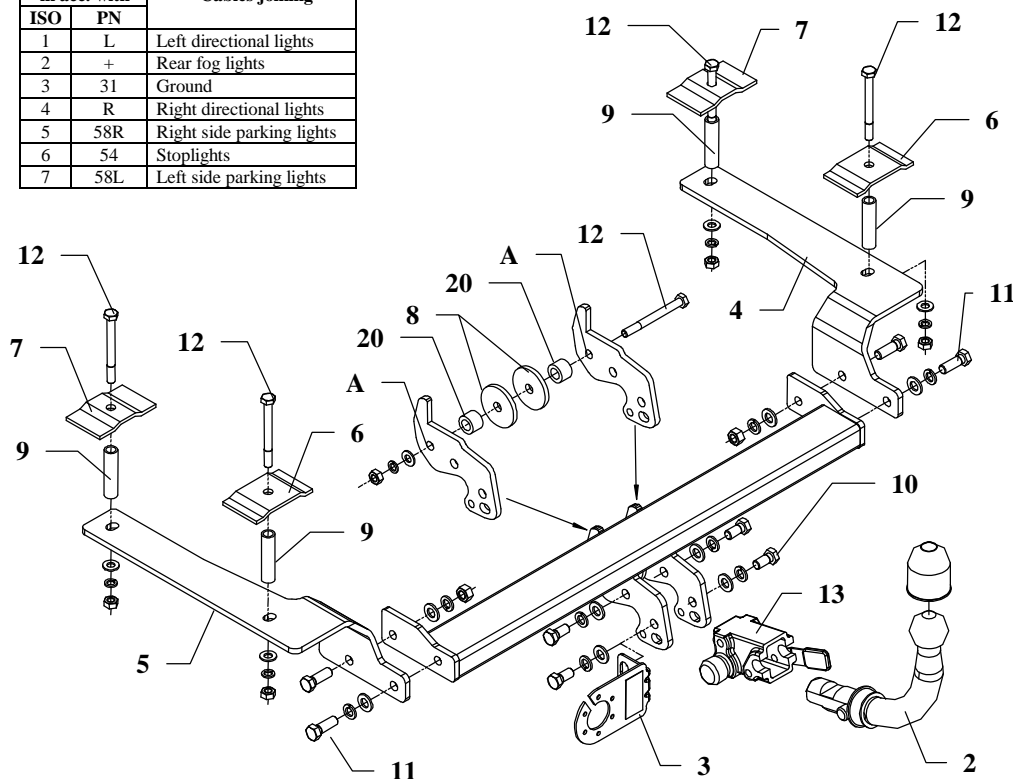

This towbar is designed to assembly in following car:
SUZUKI SWIFT, 4 doors, produced since 1989 till 09.1996, catalogue number **W01A** and is prepared to tow trailers max total weight **1000 kg** and max vertical load **50 kg**.

The instruction of the assembly

1. Disassemble the muffler.
2. Take out the fitted carpet from the trunk.
3. Find plastic protruding plugs (pins) on the left and right side in the trunk. Take them out. Raised holes are base holes. Mark second holes as shown on the figure 2. Next drill marked holes straight through using bit $\phi 11\text{mm}$, then enlarge it only from luggage part by bit $\phi 17\text{mm}$.

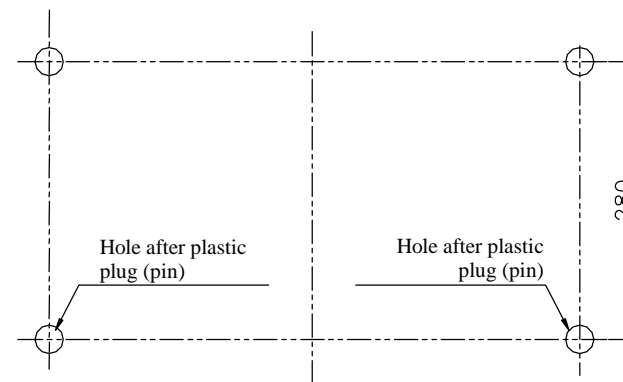

Fig. 2

4. To prepared holes put distance sleeves $\phi 17\text{mm}$, $L=70\text{mm}$ (pos. 9).
5. On holes put fish-plates (pos. 6 and 7) as shown on figure 1, next put bolts $M10 \times 100\text{mm}$ (pos. 12).
6. Underneath the car, to the chassis frame put side brackets (pos. 4 and 5) and fix it loosely.
7. Between installed brackets put main bar of the towbar (pos. 1) and fix it loosely using bolts $M12 \times 35\text{mm}$ (pos. 11).
8. Through holes pos. A fix with original towing eye using distance sleeves (pos. 20), washers $\phi 58 \times \phi 12 \times 6\text{mm}$ (pos. 8) and bolt $M10 \times 75\text{mm}$ (pos. 13).
9. Fix tight all bolts according to the torque shown in the table.
10. Reassemble the muffler.
11. Fix body of the automat (pos. 13) and the socket plate (pos. 3) using bolts $M12 \times 25\text{mm}$ (pos. 10) from accessories. Place tow-ball (pos. 2) according to supplied instruction.
12. Connect electric wires of 7-poles socket according to the instruction of the car. (Recommend to make at authorized service station)
13. Complete paint layer damaged during installation.

Torque settings for nuts and bolts (8,8):	
M 8 - 25 Nm	M 10 - 55 Nm
M 12 - 85 Nm	M 14 - 135 Nm











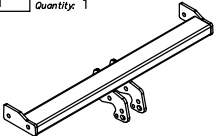
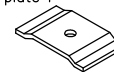







NOTE

After install the towbar you should get adequate note in registration book (at authorised service station). The car should be equipped with:

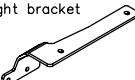
- Indicators
- Tow mirrors

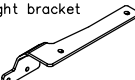
After 1000km check all bolts and nuts. The ball of towbar must be always kept clear and conserve with a grease.

Towbar accessories:

Pos. 1 Name: Main bar Quantity: 1	Pos. 6 Name: Fish-plate I Quantity: 2	Pos. 12 Name: Bolt 8,8 B Quantity: 5 Dim.: M10x100mm	Pos. 18 Name: Spring washer Quantity: 8 Dim.: \varnothing 12,2 mm
	Pos. 7 Name: Fish-plate II Quantity: 2	Pos. 13 Name: Body of the automat Quantity: 1	Pos. 19 Name: Spring washer Quantity: 5 Dim.: \varnothing 10,2 mm
			
Pos. 2 Name: Tow ball Quantity: 1	Pos. 8 Name: Washer Quantity: 2 Dim.: \varnothing 58x \varnothing 12x6mm	Pos. 14 Name: Nut 8 B Quantity: 2 Dim.: M12	Pos. 20 Name: Distance sleeve II Quantity: 4 Dim.: \varnothing 23x \varnothing 17mm L=70mm
			
Pos. 3 Name: Socket plate Quantity: 1	Pos. 9 Name: Distance sleeve I Quantity: 4 Dim.: \varnothing 17,2x2,35mm L=70mm	Pos. 15 Name: Nut 8 B Quantity: 5 Dim.: M10	Pos. 21 Name: Ball cover Quantity: 1
			
Pos. 4 Name: Right bracket Quantity: 1	Pos. 10 Name: Bolt 8,8 B Quantity: 4 Dim.: M12x25mm	Pos. 16 Name: Plain washer Quantity: 8 Dim.: \varnothing 13 mm	Pos. 22 Name: Body plug Quantity: 1
			
Pos. 5 Name: Left bracket Quantity: 1	Pos. 11 Name: Bolt 8,8 B Quantity: 4 Dim.: M12x35mm	Pos. 17 Name: Plain washer Quantity: 5 Dim.: \varnothing 10,5 mm	
			



PPUH AUTO-HAK S.J.

Produkcja Haków Holowniczych
Henryk & Zbigniew Nejman
76-200 SŁUPSK ul. Słoneczna 16K
tel/fax (059) 8-414-414; 8-414-413
e-mail: office@autohak.com.pl
www.autohak.com.pl

Towing hitch (without electrical set)

Class: **A50-X** Cat. no. **W01A**

Designed for:

Manufacturer: **SUZUKI**

Model: **SWIFT**

Type: **4 doors**

produced since 1989 till 09.1996

Technical data:

D-value: 5,45 kN

maximum trailer weight: **1000 kg**

maximum vertical cup load: **50 kg**

Approval number according to Directive 94/20/EC: e20*94/20*0059*00

Foreword

This towbar is designed according to rules of safety traffic regulations. The towing hitch is a safety component and can be install only by qualified personnel. Any alteration or conversion of the towing hitch is prohibited and would lead to cancellation of design certification. Remove insulating compound and underseal from vehicle (if present) in the area of the matting surfaces of the towing hitch. The vehicle manufacturer's specifications regarding trailer load and max. vertical cup load are decisive for driving, and values for the towing hitch cannot be exceeded.

D-value formula:

$$\frac{\text{Max trailer weight [kg]} \times \text{Max vehicle weight [kg]}}{\text{Max trailer weight [kg]} + \text{Max vehicle weight [kg]}} \times \frac{9,81}{1000} = D \text{ [kN]}$$